

HyperShear™ HPLC and UHPLC Mixers

Reduce baseline noise, increase sensitivity and improve gradient accuracy
Decrease mixing and delay volume without sacrificing mixing efficiency
Increase reaction efficiency for post column derivatization



ASI

HyperShear™

HPLC and UHPLC Mixer Features

- Static Mixers are available in Micro Flow, Low Flow, Analytical Flow, High Flow, Prep Flow and In-Line Combo Series**
- Reduce baseline noise, increase sensitivity and improve gradient accuracy**
- UHPLC mixers are available in volumes ranging from 0.5 µL to 1.5 mL and pressure to 18,000 PSI**
- Available for In-line, Binary and Ternary formats in 316 Stainless Steel**
- PEEK biocompatible is available**
- Ideal for microbore HPLC, UHPLC and LC/MS**
- Compact design is easily integrated into any HPLC and UHPLC system**
- Increase reaction efficiency for post column derivatization**
- Decrease mixing and delay volume without sacrificing mixing efficiency**
- Mixing volume optimization is easy with interchangeable mixer cartridges**
- Also we offer Dynamic Mixers**

HyperShear™ HPLC and UHPLC Mixers

ASI manufactures a wide range of Static Mixers to solve the most demanding high pressure mixing problems. ASI HyperShear Mixers incorporate a highly efficient cross-flow shearing mechanism which produces vortex shear mixing over a wide flow range. This mixing technology typically delivers between 25% to 200% better mixing efficiency compared to conventional packed bed or tortuous path mixers. HyperShear Mixers are available in a variety of housing formats including: inline, binary, and ternary inlets. Mixers are constructed from 316 stainless steel with volumes ranging from 0.5 μ L to 15.0 mL. or Biocompatible PEEK with volumes ranging from 0.5 μ L to 1.5 mL. Please contact us for Prep Flow Series (3.0 mL - 15 mL).

Within a given mixer flow series, mixer cartridges are interchangeable. The ability to swap mixer cartridges within a given mixer series makes selecting the optimum mixer volume easy and economical. UHPLC mixers, In-Line Combo Series and Prep Flow Series (3.0 mL - 15 mL) are only sold as complete assemblies. We also offer the Dynamic Mixers.

Static Mixer Specifications

	Standard HPLC	UHPLC	Biocompatible PEEK
Pressure Rating	6,000 PSI	18,000 PSI	3,000 PSI
Female Port Geometry	10/32 Parker (1/16 CPI)	10/32 Parker (1/16 CPI)	10/32 Parker (1/16 CPI)
Wetted Materials	Stainless Steel and PEEK	Stainless Steel and PEEK	PEEK
Micro Flow Series 0.5, 1, 2, 5, 10 and 25 μ L	available	available	available
Low Flow Series 50, 150 and 150 μ L	available	available	available
Analytical Flow Series 350 and 500 μ L	available	available	available (In-Line)
High Flow Series 800 μ L, 1.0 and 1.5 mL	available	available	available (In-Line)
Prep Flow Series 3.0, 6.0, 9.0 and 15 mL	available	not available	not available
In-Line Combo Series 1 to 100 μ L	available (In-Line)	available (In-Line)	available (In-Line)

Static Mixer Application Notes

Selecting the Right Size Mixer Cartridge

ASI offers static mixers with volumes that range from 0.5 μL to 15 mL. Choosing the right size mixer is a trade off between delay volume, mixing noise, gradient fidelity and chromatographic performance. ***Please refer to the data “Effect of Mixer Volume on Gradient Accuracy with a Constant Flow Rate” for more information on gradient accuracy as a function of flow rate and mixing volume.***

The following observations will provide some guidelines to help choose the right size mixer.

- For any given flow rate, the more the mixing volume the better the mixing, and the lower the baseline noise.
- The smaller the mixing volume, the better the definition and sharpness of linear gradients.
- Multi-pump high pressure gradient systems typically require far less mixing volume than low pressure single pump gradient systems when running linear gradients.
- An ASI 150 μL in-line static mixer can be added in addition to the standard onboard mixer to further reduce mixing noise.

Multi-pump High Pressure Gradient Systems

Linear Gradients

Select the largest volume possible to minimize the mixing noise. The upper limits to mixing volume will be the maximum delay time that can be tolerated, and possible distortion (tailing) of the gradient at the beginning and end of the gradient. The lower limit will be defined by the amount of mixing noise that can be tolerated.

Please refer to a table on Page 5, Mixer Selection Guide for specific recommendations.

Binary or Ternary – Steady State Composition

Always select the largest volume that will still provide an acceptable delay volume. In general, the more mixing volume, the better the mixing will be. For most pump systems, a 150 μL cartridge will provide adequate mixing.

Examples of this type of pump system include: Shimadzu LC-10AD and LC-10ADvp, Gilson Model 305, Agilent Model 1100, 1200, Waters Alliance, Acquity, Perkin Elmer Flexar

Single-pump Low Pressure Mixing Gradient Systems

Linear Gradients

These systems generally require more mixing volume to perform linear gradients than multi-pump high pressure systems. The following will explain why this is the case. In a low pressure system the composition can only be changed once every pump stroke. Since the pump stroke volume of most pumps is 100 μL , and it takes a mixer volume that is about 3 times the batch volume to provide adequate mixing, we need 350 μL of mixer volume, at least, to do adequate mixing. More insoluble combinations may require even more mixing volume.

In general, choose the largest size mixer cartridge that will still provide an acceptable delay volume. For most applications this will be at least 350 μL .

Binary or Ternary – Steady State Composition

Always select the largest volume that will still provide an acceptable delay time. In general, the more mixing volume, the better the mixing will be. For most applications this will be at least 350 μL .

Examples of this type of pump system include: Agilent 1100, Perkin Elmer series 200, TSP Spectra Vision®.

TFA Mixing Noise

Eliminating mixing noise from TFA requires either a dynamic mixer, or a large static mixer. In the Agilent 1100 system, we recommend using the ASI 1.00 mL dynamic mixer, Part Number: 462-1000A. An equivalent result will be obtained with the ASI 1.5 mL static mixer, Part Number: 431-1500. Consult ASI technical support for recommendations.

Mixer Cartridge Selection Guide for High Pressure Mixing

Linear Gradients - High Pressure Mixing

Larger mixing volume can be tolerated for a particular flow rate, with the larger the volume the lower the mixing noise. The upper limits to mixing volume will be the maximum delay time that can be tolerated, and possible distortion (tailing) of the gradient at the beginning and end of the gradient. The lower limit will be defined by the amount of mixing noise that can be tolerated. The following cartridge volumes are a compromise between these two limits.

Table 1.

Flow	Mixer Cartridge Volume
< 1 $\mu\text{L}/\text{min.}$	0.5 μL
0.5 $\mu\text{L}/\text{min.}$ - 2 $\mu\text{L}/\text{min.}$	1 μL
1 $\mu\text{L}/\text{min.}$ - 5 $\mu\text{L}/\text{min.}$	2 μL
2 $\mu\text{L}/\text{min.}$ - 10 $\mu\text{L}/\text{min.}$	5 μL
5 $\mu\text{L}/\text{min.}$ - 20 $\mu\text{L}/\text{min.}$	10 μL
10 $\mu\text{L}/\text{min.}$ - 50 $\mu\text{L}/\text{min.}$	25 μL
20 $\mu\text{L}/\text{min.}$ - 100 $\mu\text{L}/\text{min.}$	50 μL
100 $\mu\text{L}/\text{min.}$ - 250 $\mu\text{L}/\text{min.}$	150 μL
200 $\mu\text{L}/\text{min.}$ - 500 $\mu\text{L}/\text{min.}$	250 μL
500 $\mu\text{L}/\text{min.}$ - 2 $\text{mL}/\text{min.}$	350 μL
1 $\text{mL}/\text{min.}$ - 5 $\text{mL}/\text{min.}$	500 μL
2 $\text{mL}/\text{min.}$ - 10 $\text{mL}/\text{min.}$	800 μL
5 $\text{mL}/\text{min.}$ - 20 $\text{mL}/\text{min.}$	1.0 mL
10 $\text{mL}/\text{min.}$ - 30 $\text{mL}/\text{min.}$	1.5 mL
20 $\text{mL}/\text{min.}$ - 50 $\text{mL}/\text{min.}$	3.0 mL
30 $\text{mL}/\text{min.}$ - 80 $\text{mL}/\text{min.}$	6.0 mL
50 $\text{mL}/\text{min.}$ - 100 $\text{mL}/\text{min.}$	9.0 mL
80 $\text{mL}/\text{min.}$ - 1 $\text{L}/\text{min.}$	15 mL

Binary Static Mixer Comparison

Less Noise - Lower Detection Limits

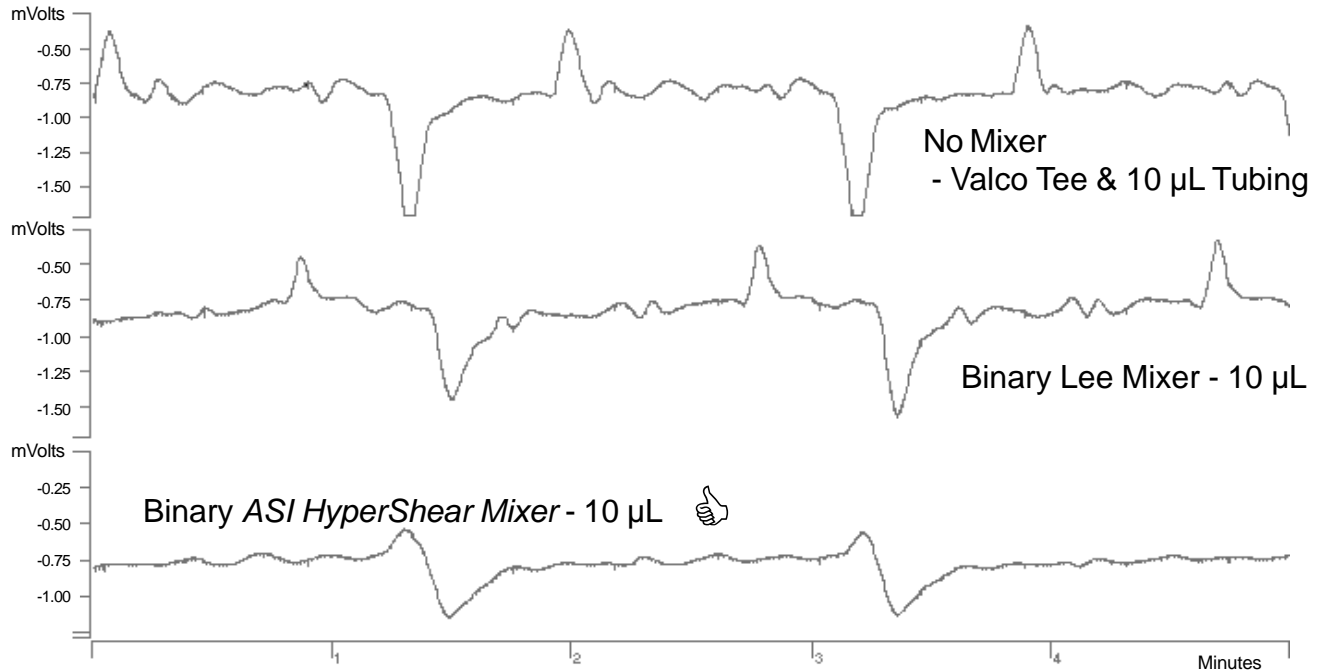

HPLC System Configuration:
AS/Model 500G Gradient System
ABI Model 785 UV/VIS @254 on-column
Varian Star Data Acquisition

HPLC Conditions:
MP: A = H₂O, B = H₂O/Acetone
Flow Rate: 50 μ L/min. 50% B
Pressure: 1,700 PSI with AS/resistor cartridge

Figure 1

Superior Mixing with Less Gradient Dispersion

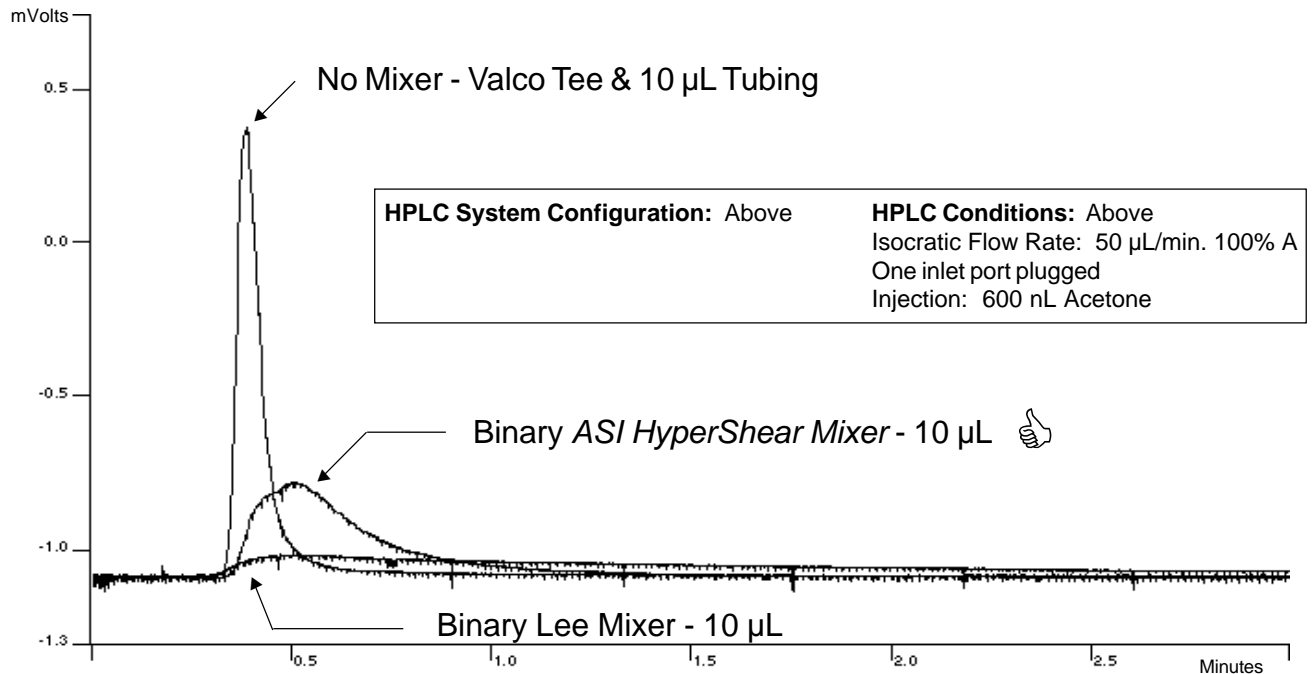

HPLC System Configuration: Above

HPLC Conditions: Above
Isocratic Flow Rate: 50 μ L/min. 100% A
One inlet port plugged
Injection: 600 nL Acetone

Figure 2

Agilent Static Mixer Optimization

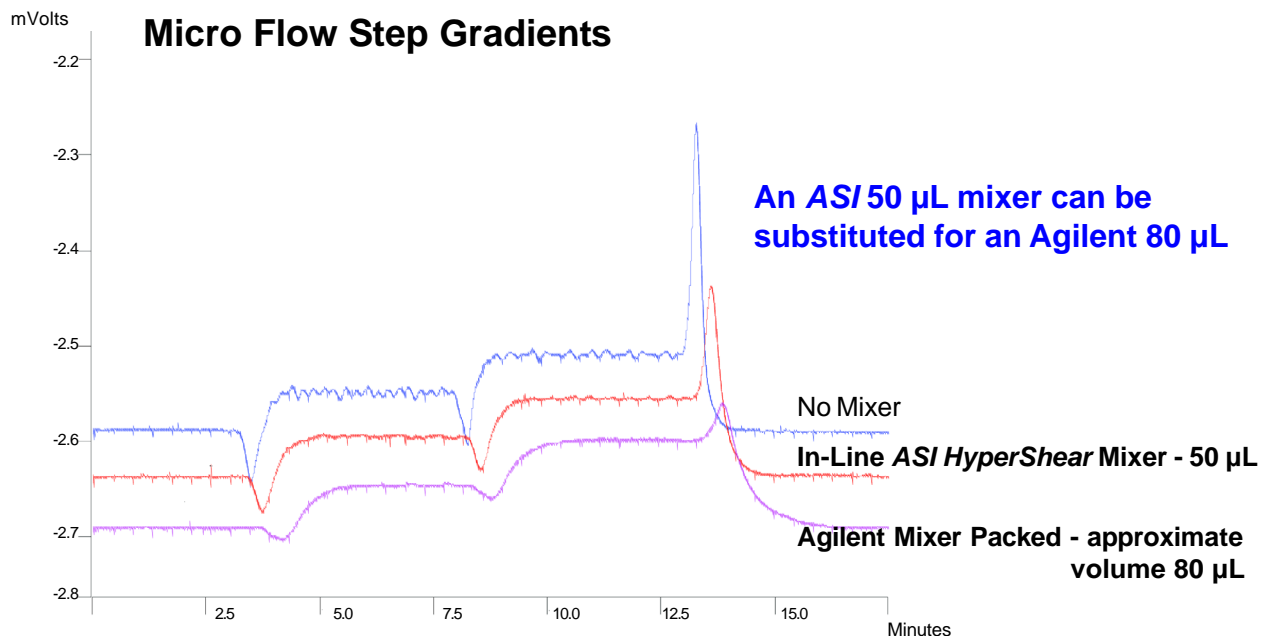

HPLC System Configuration:

Agilent® Binary 1100 Pump
 Packed bed mixer (approximate volume: 80 µL) replaced
 with union and/or ASI HyperShear In-Line Static Mixer
 Varian Star Data Acquisition

HPLC Conditions:

MP: A = H₂O, B = ACN doped with 0.01% Acetone
 Flow Rate: 250 µL/min.
 Pressure: 2,000 PSI with ASI resistor cartridge
 Gradient: 0.0 = off%B 7.5 = 20%B
 2.5 = 10%B 12.4 = 20%B
 7.4 = 10%B 12.5 = 0.0%B and hold

Figure 3

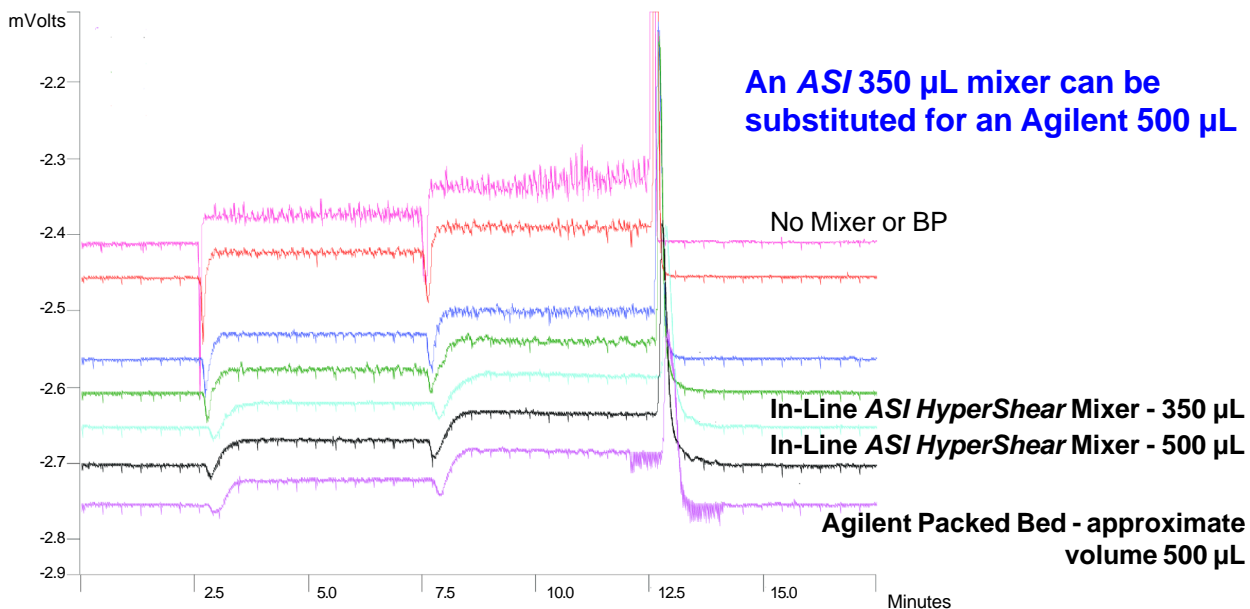

HPLC System Configuration: Above

Agilent® Binary 1100 Pump
 Packed bed mixer (approximate volume: 500 µL) replaced
 with union and/or ASI HyperShear In-Line Static Mixer
 Varian Star Data Acquisition

HPLC Conditions:

MP: A = H₂O, B = IPA doped with 0.01% Acetone
 Flow Rate: 1.0 mL/min.
 Pressure: 2,000 PSI with ASI resistor cartridge
 Gradient: Above

Figure 4

Shimadzu Static Mixer Optimization

Micro Flow Step Gradients

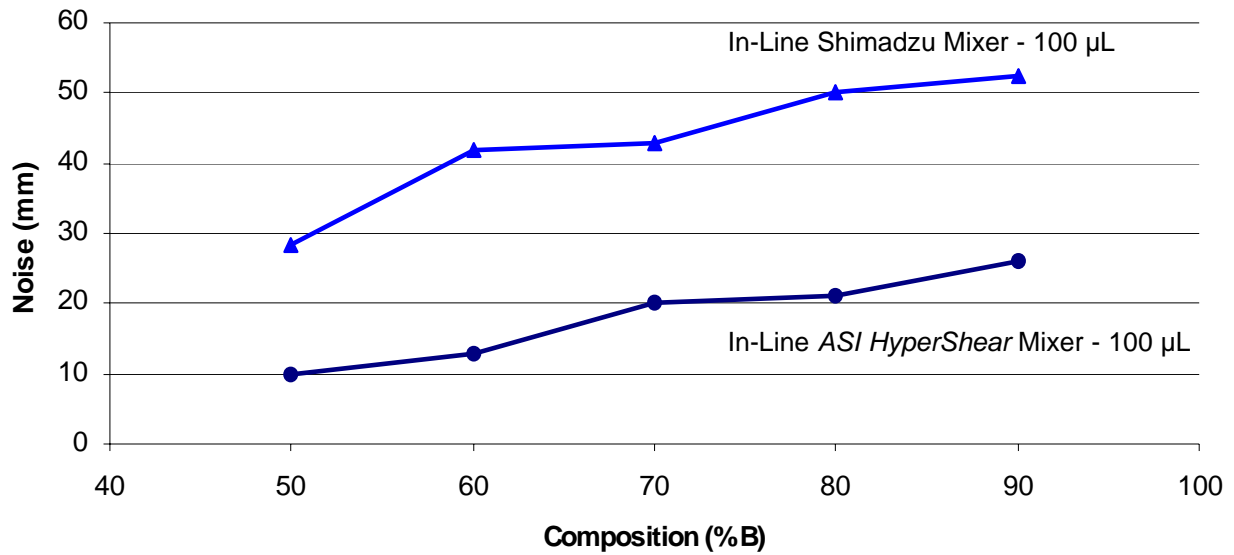
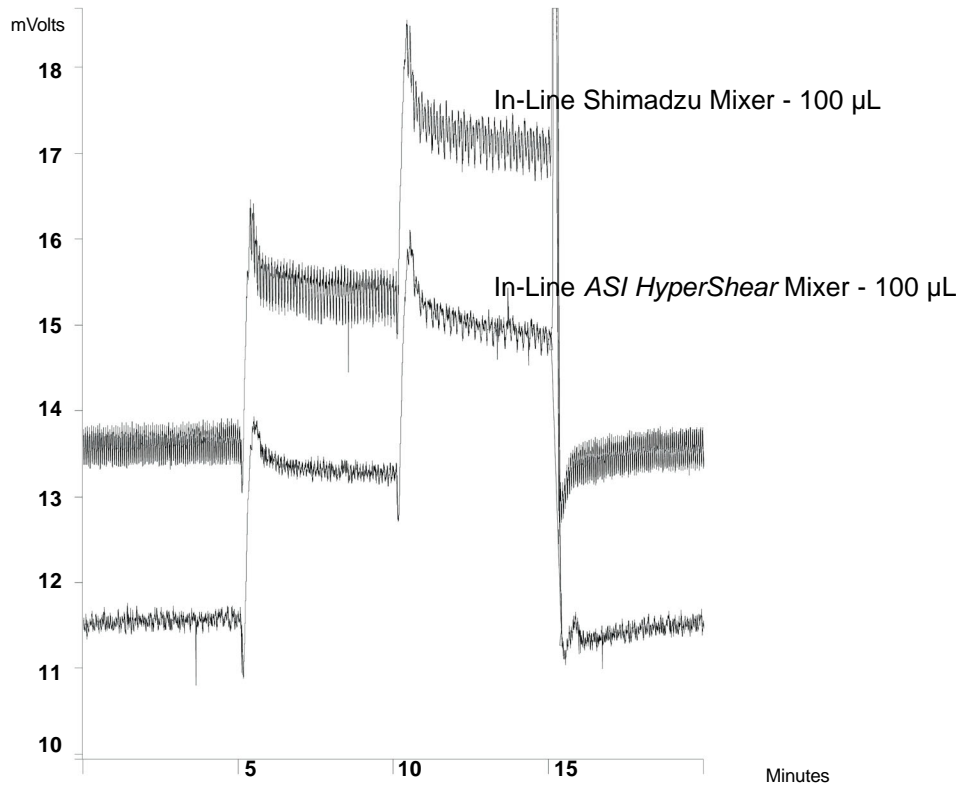

Figure 5

Micro Flow Step Gradients



HPLC System Configuration:

Shimadzu: LC-10ADvp
Mixer: Connected at Shimadzu Tee
Detector: Knauer 2501 @254

HPLC Conditions:

MP: A = H₂O, B = H₂O + 35% 2-Propanol + 0.003% Acetone
Flow Rate: 250 µL/min.
Pressure: 2,000 PSI with ASI resistor cartridge

Figure 6

Shimadzu Static Mixer Optimization

Analytical Flow Step Gradients

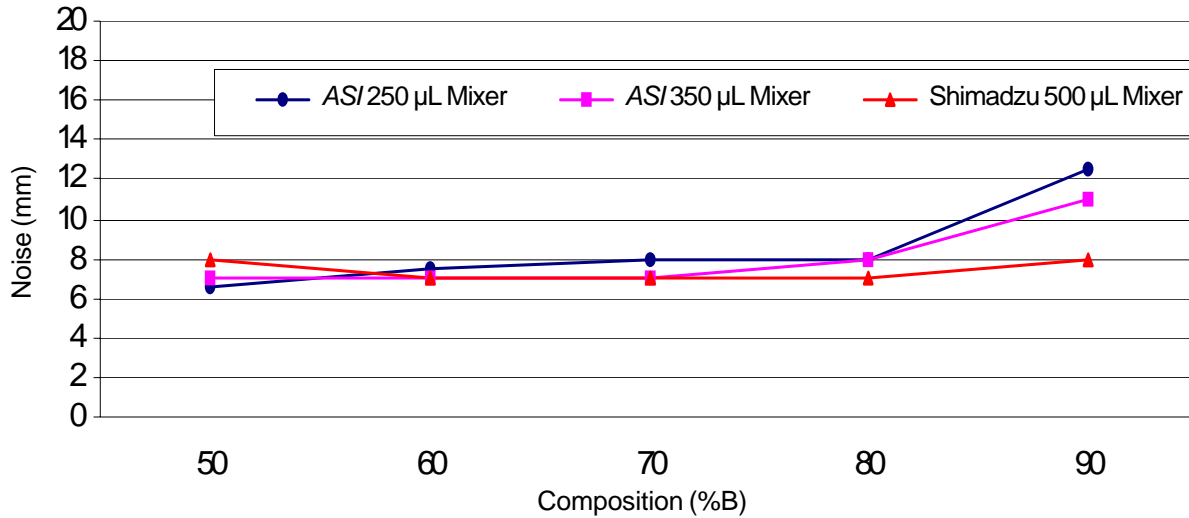

HPLC System Configuration:

Shimadzu: LC-10ADvp
 Mixer: Connected at Shimadzu Tee
 Detector: Knauer 2501 @254

HPLC Conditions:

MP: A = H₂O, B = H₂O + 35% 2-Propanol + 0.003% Acetone
 Flow Rate: 1.0 mL/min.
 Pressure: 2,000 PSI with ASI resistor cartridge

Figure 7

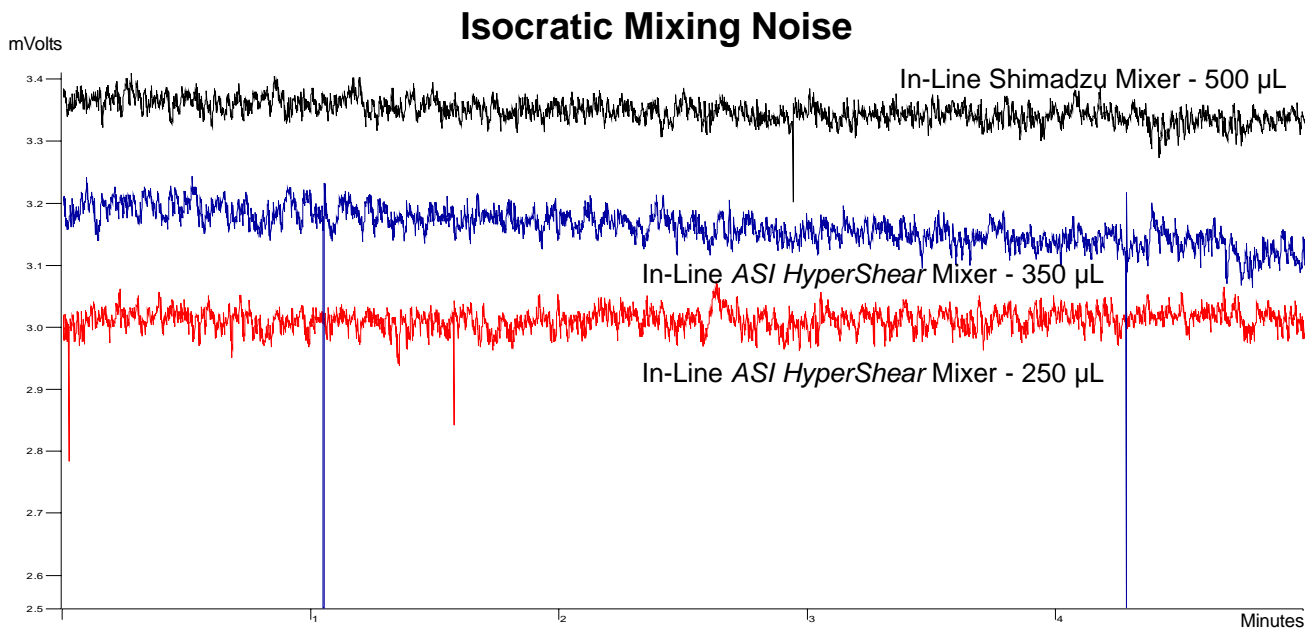

HPLC System Configuration:

Shimadzu: LC-10ADvp
 Mixer: Connected at Shimadzu Tee
 Detector: Knauer 2501 @254

HPLC Conditions:

MP: A = H₂O, B = H₂O + 35% 2-Propanol + 0.003% Acetone
 Flow Rate: 1.0 mL/min.
 Pressure: 2,000 PSI with ASI resistor cartridge

Figure 8

Effect of Mixer Volume on Gradient Accuracy with a Constant Flow Rate

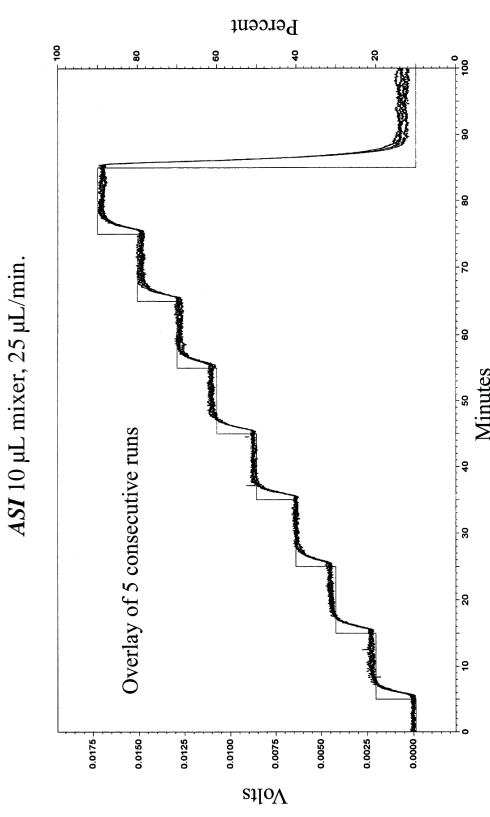
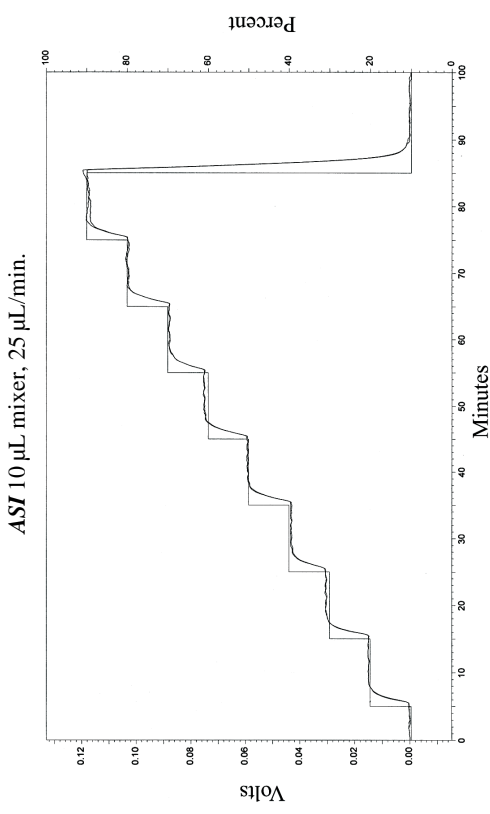
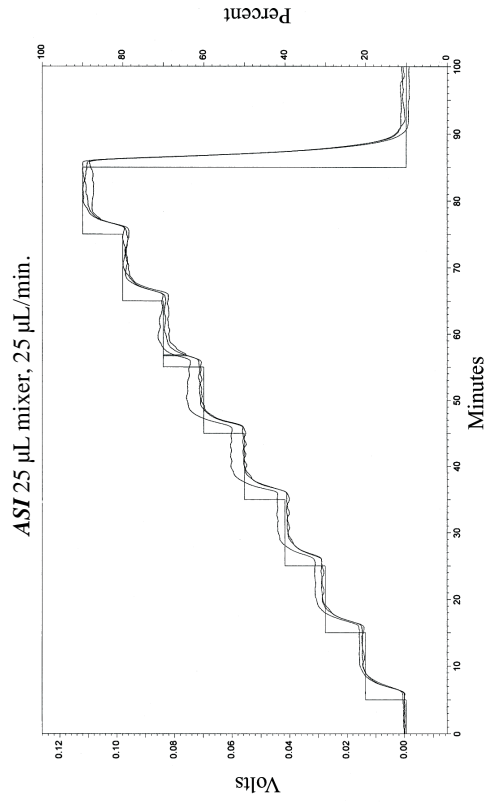
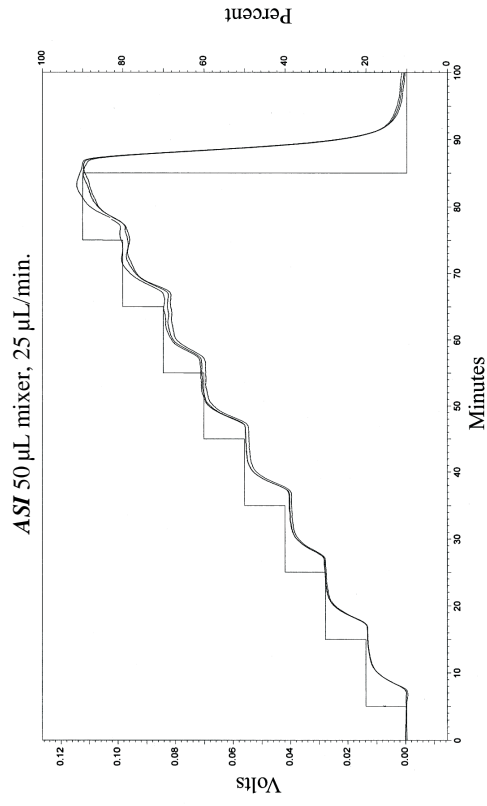

HPLC System configuration:

Shimadzu LC-10ADVP pumps with micro-flow modification
 Shimadzu SPD-10AVP UV-VIS detector
 Shimadzu Class-VP v5.03 software

HPLC conditions:

Gradient: 10-90% B in 10 min. steps
 A = H₂O
 B = 0.3% Acetone in H₂O

Effect of Flow Rate on Gradient Accuracy with a Constant Mixing Volume

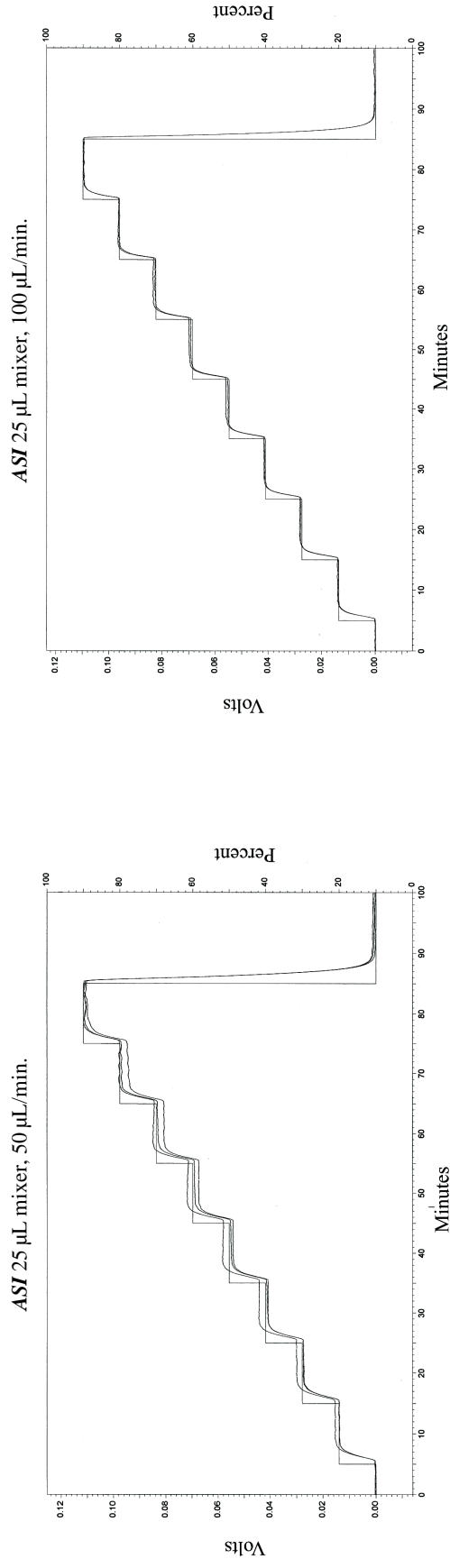
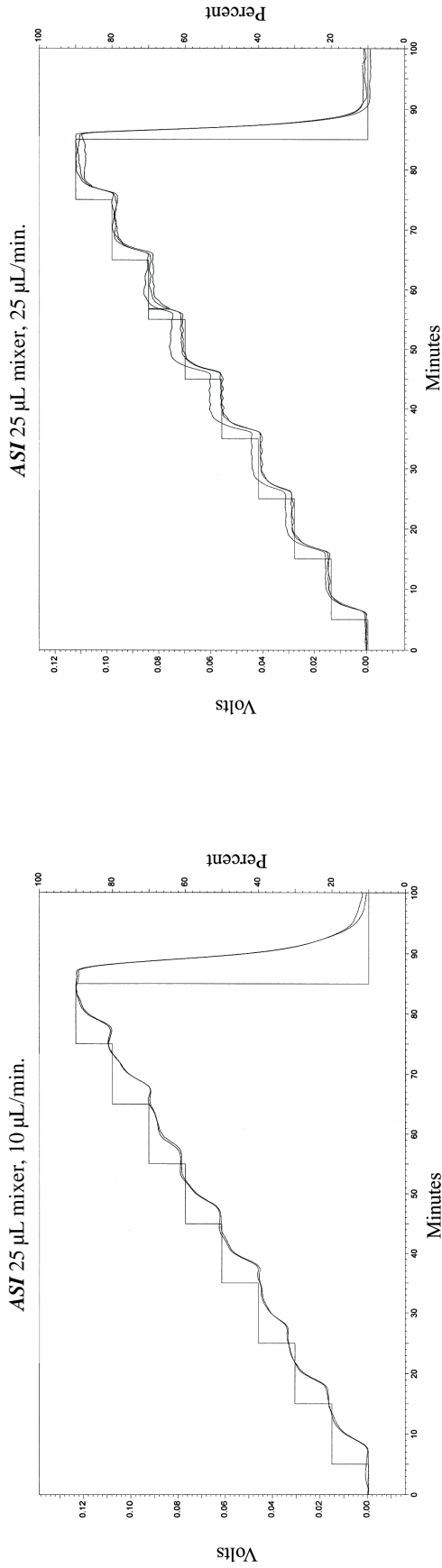

HPLC System configuration:
Shimadzu LC-10ADVP pumps with micro-flow modification
Shimadzu SPD-10AVP UV-VIS detector
Shimadzu Class-VP v5.03 software

HPLC conditions:
Gradient: 10-90% B in 10 min. steps
A = H₂O
B = 0.3% Acetone in H₂O

Figure 10

Micro Flow Series

Stainless Steel



In-Line Complete Assemblies - Cartridge and Housing

Description	ASI Part Number
In-Line Mixer Assembly SS 0.5 µL	401-000.5
In-Line Mixer Assembly SS 1 µL	401-0001
In-Line Mixer Assembly SS 2 µL	401-0002
In-Line Mixer Assembly SS 5 µL	401-0005
In-Line Mixer Assembly SS 10 µL	401-0010
In-Line Mixer Assembly SS 25 µL	401-0025

In-Line Assemblies Port Size: 10-32 CPI (Standard HPLC Fittings for 1/16" Tube)

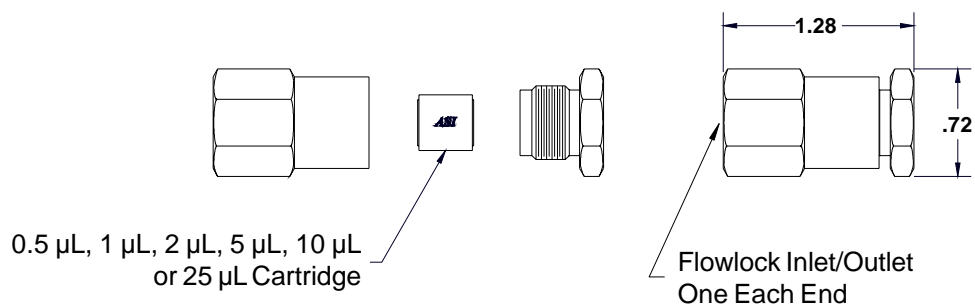

Figure 11

Binary Tee Complete Assemblies - Cartridge and Housing

Description	ASI Part Number
Binary Tee Mixer Assembly SS 0.5 μ L	402-000.5
Binary Tee Mixer Assembly SS 1 μ L	402-0001
Binary Tee Mixer Assembly SS 2 μ L	402-0002
Binary Tee Mixer Assembly SS 5 μ L	402-0005
Binary Tee Mixer Assembly SS 10 μ L	402-0010
Binary Tee Mixer Assembly SS 25 μ L	402-0025

Ternary Tee Complete Assemblies - Cartridge and Housing

Description	ASI Part Number
Ternary Tee Mixer Assembly SS 0.5 μ L	403-000.5
Ternary Tee Mixer Assembly SS 1 μ L	403-0001
Ternary Tee Mixer Assembly SS 2 μ L	403-0002
Ternary Tee Mixer Assembly SS 5 μ L	403-0005
Ternary Tee Mixer Assembly SS 10 μ L	403-0010
Ternary Tee Mixer Assembly SS 25 μ L	403-0025

Binary/Ternary Assemblies Port Size: 10-32 CPI (Standard HPLC Fittings for 1/16" Tube)

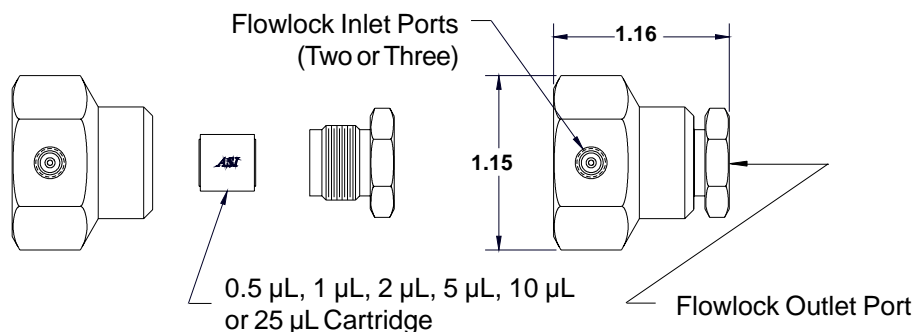

Figure 12

Cartridges / Housings

Description	ASI Part Number
Mixer Cartridge SS 0.5 μ L	400-000.5
Mixer Cartridge SS 1 μ L	400-0001
Mixer Cartridge SS 2 μ L	400-0002
Mixer Cartridge SS 5 μ L	400-0005
Mixer Cartridge SS 10 μ L	400-0010
Mixer Cartridge SS 25 μ L	400-0025
In-Line Micro Flow Series SS Housing	401-0000
Binary Tee Micro Flow Series SS Housing	402-0000
Ternary Tee Micro Flow Series SS Housing	403-0000

UHPLC In-Line Complete Assemblies - Cartridge and Housing

Description	ASI Part Number
In-Line Mixer Assembly SS 0.5 μ L, HP	401-000.5HP
In-Line Mixer Assembly SS 1 μ L, HP	401-0001HP
In-Line Mixer Assembly SS 2 μ L, HP	401-0002HP
In-Line Mixer Assembly SS 5 μ L, HP	401-0005HP
In-Line Mixer Assembly SS 10 μ L, HP	401-0010HP
In-Line Mixer Assembly SS 25 μ L, HP	401-0025HP

UHPLC Binary Tee Complete Assemblies - Cartridge and Housing

Description	ASI Part Number
Binary Tee Mixer Assembly SS 0.5 μ L, HP	402-000.5HP
Binary Tee Mixer Assembly SS 1 μ L, HP	402-0001HP
Binary Tee Mixer Assembly SS 2 μ L, HP	402-0002HP
Binary Tee Mixer Assembly SS 5 μ L, HP	402-0005HP
Binary Tee Mixer Assembly SS 10 μ L, HP	402-0010HP
Binary Tee Mixer Assembly SS 25 μ L, HP	402-0025HP

UHPLC Ternary Tee Complete Assemblies - Cartridge and Housing

Description	ASI Part Number
Ternary Tee Mixer Assembly SS 0.5 μ L, HP	403-000.5HP
Ternary Tee Mixer Assembly SS 1 μ L, HP	403-0001HP
Ternary Tee Mixer Assembly SS 2 μ L, HP	403-0002HP
Ternary Tee Mixer Assembly SS 5 μ L, HP	403-0005HP
Ternary Tee Mixer Assembly SS 10 μ L, HP	403-0010HP
Ternary Tee Mixer Assembly SS 25 μ L, HP	403-0025HP

Micro Flow Series

Biocompatible PEEK



In-Line Complete Assemblies - Cartridge and Housing

Description	ASI Part Number
In-Line Mixer Assembly PEEK 0.5 μL	401-000.5B
In-Line Mixer Assembly PEEK 1 μL	401-0001B
In-Line Mixer Assembly PEEK 2 μL	401-0002B
In-Line Mixer Assembly PEEK 5 μL	401-0005B
In-Line Mixer Assembly PEEK 10 μL	401-0010B
In-Line Mixer Assembly PEEK 25 μL	401-0025B

In-Line Assemblies Port Size: 10-32 CPI (Standard HPLC Fittings for 1/16" Tube)

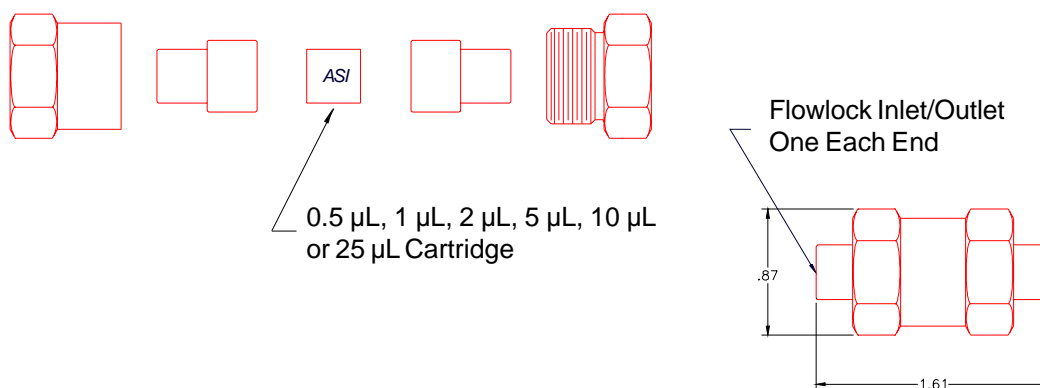

Figure 13

Binary Tee Complete Assemblies - Cartridge and Housing

Description	ASI Part Number
Binary Tee Mixer Assembly PEEK 0.5 μ L	402-000.5B
Binary Tee Mixer Assembly PEEK 1 μ L	402-0001B
Binary Tee Mixer Assembly PEEK 2 μ L	402-0002B
Binary Tee Mixer Assembly PEEK 5 μ L	402-0005B
Binary Tee Mixer Assembly PEEK 10 μ L	402-0010B
Binary Tee Mixer Assembly PEEK 25 μ L	402-0025B

Ternary Tee Complete Assemblies - Cartridge and Housing

Description	ASI Part Number
Ternary Tee Mixer Assembly PEEK 0.5 μ L	403-000.5B
Ternary Tee Mixer Assembly PEEK 1 μ L	403-0001B
Ternary Tee Mixer Assembly PEEK 2 μ L	403-0002B
Ternary Tee Mixer Assembly PEEK 5 μ L	403-0005B
Ternary Tee Mixer Assembly PEEK 10 μ L	403-0010B
Ternary Tee Mixer Assembly PEEK 25 μ L	403-0025B

Binary/Ternary Assemblies Port Size: 10-32 CPI (Standard HPLC Fittings for 1/16" Tube)

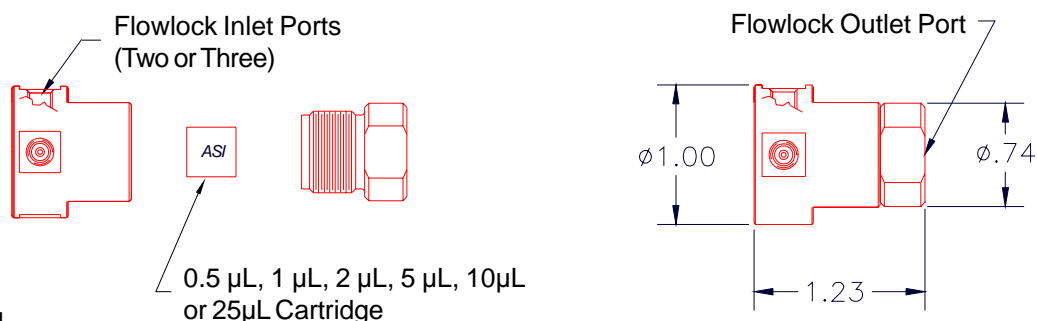

Figure 14

Cartridges / Housings

Description	ASI Part Number
Mixer Cartridge PEEK 0.5 μ L	400-000.5B
Mixer Cartridge PEEK 1 μ L	400-0001B
Mixer Cartridge PEEK 2 μ L	400-0002B
Mixer Cartridge PEEK 5 μ L	400-0005B
Mixer Cartridge PEEK 10 μ L	400-0010B
Mixer Cartridge PEEK 25 μ L	400-0025B
In-Line Micro Flow Series PEEK Housing	401-0000B
Binary Tee Micro Flow Series PEEK Housing	402-0000B
Ternary Tee Micro Flow Series PEEK Housing	403-0000B

Low Flow Series

Stainless Steel



In-Line Complete Assemblies - Cartridge and Housing

Description	ASI Part Number
In-Line Mixer Assembly SS 50 μ L	411-0050
In-Line Mixer Assembly SS 150 μ L	411-0150
In-Line Mixer Assembly SS 250 μ L	411-0250

In-Line Assemblies Port Size: 10-32 CPI (Standard HPLC Fittings for 1/16" Tube)

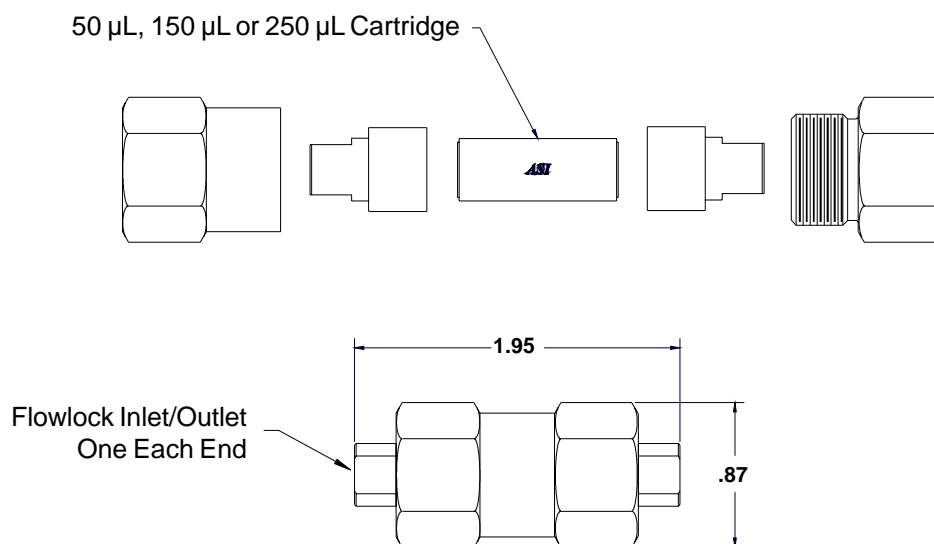

Figure 15

Binary Tee Complete Assemblies - Cartridge and Housing

Description	ASI Part Number
Binary Tee Mixer Assembly SS 50 μ L	412-0050
Binary Tee Mixer Assembly SS 150 μ L	412-0150
Binary Tee Mixer Assembly SS 250 μ L	412-0250

Ternary Tee Complete Assemblies - Cartridge and Housing

Description	ASI Part Number
Ternary Tee Mixer Assembly SS 50 μ L	413-0050
Ternary Tee Mixer Assembly SS 150 μ L	413-0150
Ternary Tee Mixer Assembly SS 250 μ L	413-0250

Binary/Ternary Assemblies Port Size: 10-32 CPI (Standard HPLC Fittings for 1/16" Tube)

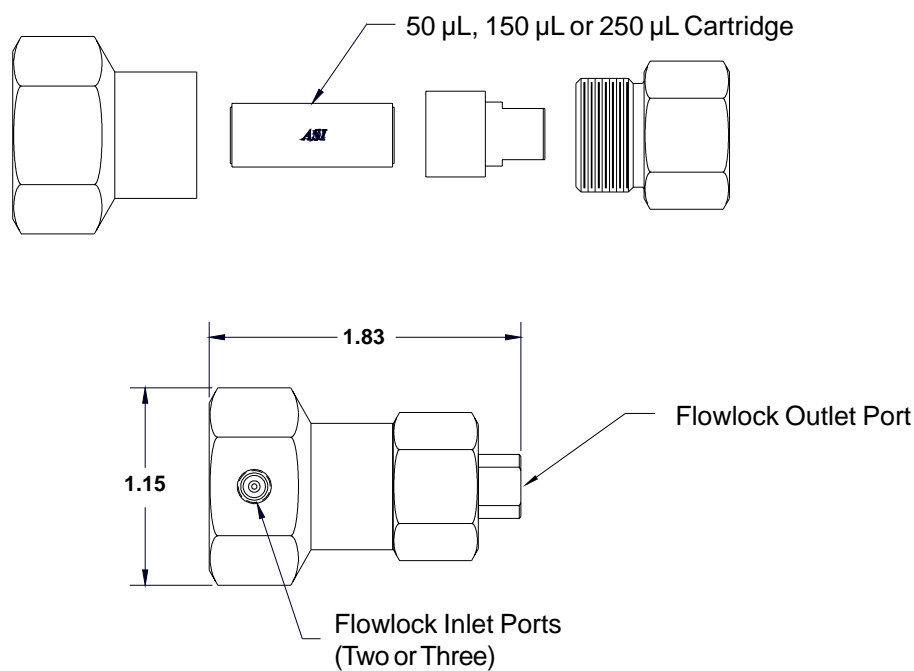

Figure 16

Cartridges / Housings

Description	ASI Part Number
Mixer Cartridge SS 50 μ L	410-0050
Mixer Cartridge SS 150 μ L	410-0150
Mixer Cartridge SS 250 μ L	410-0250
In-Line Low Flow Series SS Housing	411-0000
Binary Tee Low Flow Series SS Housing	412-0000
Ternary Tee Low Flow Series SS Housing	413-0000

UHPLC In-Line Complete Assemblies - Cartridge and Housing

Description	ASI Part Number
In-Line Mixer Assembly SS 50 μ L, HP	411-0050HP
In-Line Mixer Assembly SS 150 μ L, HP	411-0150HP
In-Line Mixer Assembly SS 250 μ L, HP	411-0250HP

UHPLC Binary Tee Complete Assemblies - Cartridge and Housing

Description	ASI Part Number
Binary Tee Mixer Assembly SS 50 μ L, HP	412-0050HP
Binary Tee Mixer Assembly SS 150 μ L, HP	412-0150HP
Binary Tee Mixer Assembly SS 250 μ L, HP	412-0250HP

UHPLC Ternary Tee Complete Assemblies - Cartridge and Housing

Description	ASI Part Number
Ternary Tee Mixer Assembly SS 50 μ L, HP	413-0050HP
Ternary Tee Mixer Assembly SS 150 μ L, HP	413-0150HP
Ternary Tee Mixer Assembly SS 250 μ L, HP	413-0250HP

Low Flow Series

Biocompatible PEEK



In-Line Complete Assemblies - Cartridge and Housing

Description	ASI Part Number
In-Line Mixer Assembly PEEK 50 µL	411-0050B
In-Line Mixer Assembly PEEK 150 µL	411-0150B
In-Line Mixer Assembly PEEK 250 µL	411-0250B

In-Line Assemblies Port Size: 10-32 CPI (Standard HPLC Fittings for 1/16" Tube)

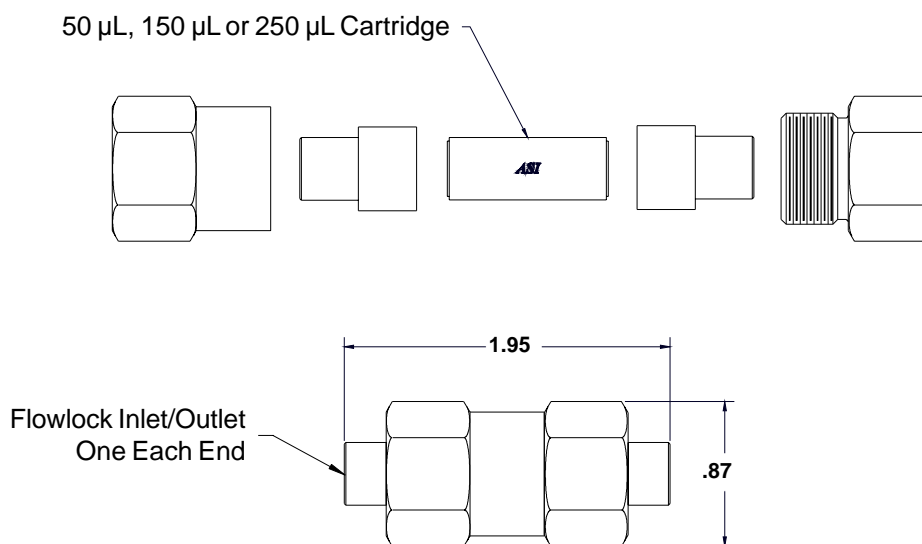

Figure 17

Binary Tee Complete Assemblies - Cartridge and Housing

Description	ASI Part Number
Binary Tee Mixer Assembly PEEK 50 μ L	412-0050B
Binary Tee Mixer Assembly PEEK 150 μ L	412-0150B
Binary Tee Mixer Assembly PEEK 250 μ L	412-0250B

Ternary Tee Complete Assemblies - Cartridge and Housing

Description	ASI Part Number
Ternary Tee Mixer Assembly PEEK 50 μ L	413-0050B
Ternary Tee Mixer Assembly PEEK 150 μ L	413-0150B
Ternary Tee Mixer Assembly PEEK 250 μ L	413-0250B

Binary/Ternary Assemblies Port Size: 10-32 CPI (Standard HPLC Fittings for 1/16" Tube)

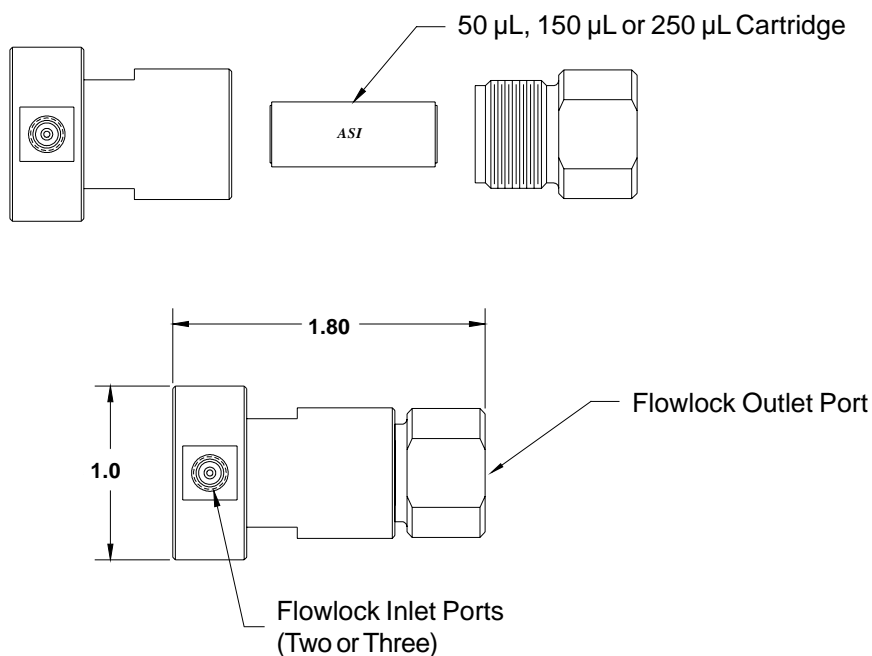

Figure 18

Cartridges / Housings

Description	ASI Part Number
Mixer Cartridge PEEK 50 μ L	410-0050B
Mixer Cartridge PEEK 150 μ L	410-0150B
Mixer Cartridge PEEK 250 μ L	410-0250B
In-Line Low Flow Series PEEK Housing	411-0000B
Binary Tee Low Flow Series PEEK Housing	412-0000B
Ternary Tee Low Flow Series PEEK Housing	413-0000B

Analytical Flow Series

Stainless Steel, Biocompatible PEEK



In-Line Complete Assemblies - Cartridge and Housing Stainless Steel

Description	ASI Part Number
In-Line Mixer Assembly SS 350 μ L	421-0350
In-Line Mixer Assembly SS 500 μ L	421-0500

Biocompatible PEEK

Description	ASI Part Number
In-Line Mixer Assembly PEEK 350 μ L	421-0350B
In-Line Mixer Assembly PEEK 500 μ L	421-0500B

In-Line Assemblies Port Size: 10-32 CPI (Standard HPLC Fittings for 1/16" Tube)

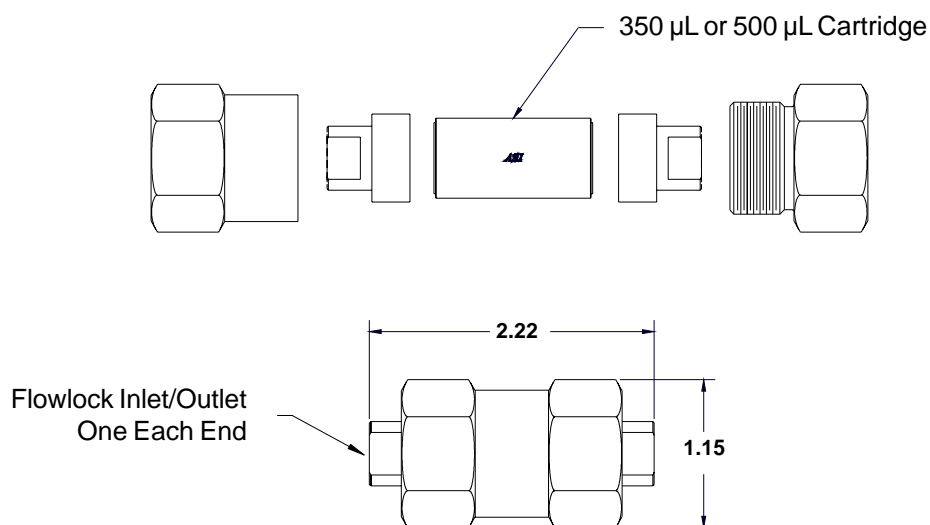

Figure 19

Binary Complete Assemblies, Stainless Steel - Cartridge and Housing

Description	ASI Part Number
Binary Tee Mixer Assembly SS 350 μ L	422-0350
Binary Tee Mixer Assembly SS 500 μ L	422-0500

Ternary Complete Assemblies, Stainless Steel - Cartridge and Housing

Description	ASI Part Number
Ternary Tee Mixer Assembly SS 350 μ L	423-0350
Ternary Tee Mixer Assembly SS 500 μ L	423-0500

Binary/Ternary Assemblies Port Size: 10-32 CPI (Standard HPLC Fittings for 1/16" Tube)

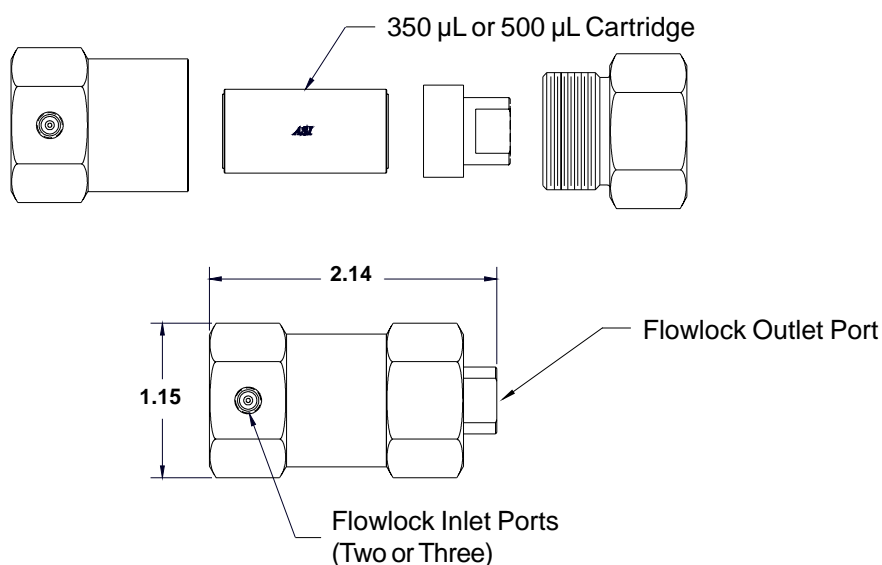

Figure 20

Cartridges / Housings Stainless Steel

Description	ASI Part Number
Mixer Cartridge SS 350 μ L	420-0350
Mixer Cartridge SS 500 μ L	420-0500
In-Line Analytical Flow Series SS Housing	421-0000
Binary Tee Analytical Flow Series SS Housing	422-0000
Ternary Tee Analytical Flow Series SS Housing	423-0000

Biocompatible PEEK

Description	ASI Part Number
Mixer Cartridge PEEK 350 μ L	420-0350B
Mixer Cartridge PEEK 500 μ L	420-0500B
In-Line Analytical Flow Series PEEK Housing	421-0000B

UHPLC In-Line Complete Assemblies - Cartridge and Housing Stainless Steel

Description	ASI Part Number
In-Line Mixer Assembly SS 350 μ L, HP	421-0350HP
In-Line Mixer Assembly SS 500 μ L, HP	421-0500HP

UHPLC Binary Complete Assemblies - Cartridge and Housing Stainless Steel

Description	ASI Part Number
Binary Tee Mixer Assembly SS 350 μ L, HP	422-0350HP
Binary Tee Mixer Assembly SS 500 μ L, HP	422-0500HP

UHPLC Ternary Complete Assemblies - Cartridge and Housing Stainless Steel

Description	ASI Part Number
Ternary Tee Mixer Assembly SS 350 μ L, HP	423-0350HP
Ternary Tee Mixer Assembly SS 500 μ L, HP	423-0500HP

Analytical Flow Series

Stainless Steel, Biocompatible PEEK



In-Line Complete Assemblies - Cartridge and Housing Stainless Steel

Description	ASI Part Number
In-Line Mixer Assembly SS 800 μ L	431-0800
In-Line Mixer Assembly SS 1.0 mL	431-1000
In-Line Mixer Assembly SS 1.5 mL	431-1500

Biocompatible PEEK

Description	ASI Part Number
In-Line Mixer Assembly PEEK 800 μ L	431-0800B
In-Line Mixer Assembly PEEK 1.0 mL	431-1000B
In-Line Mixer Assembly PEEK 1.5 mL	431-1500B

In-Line Assemblies Port Size: 10-32 CPI (Standard HPLC Fittings for 1/16" Tube)

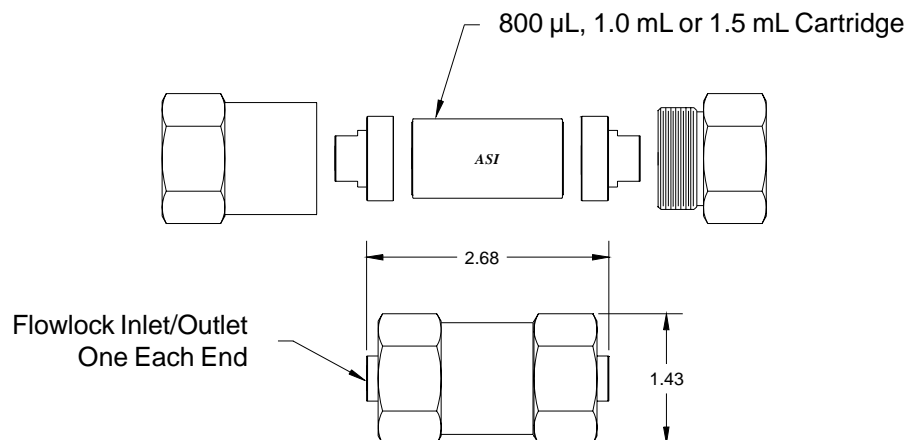

Figure 21

Binary Complete Assemblies, Stainless Steel - Cartridge and Housing

Description	ASI Part Number
Binary Tee Mixer Assembly SS 800 μ L	432-0800
Binary Tee Mixer Assembly SS 1.0 mL	432-1000
Binary Tee Mixer Assembly SS 1.5 mL	432-1500

Ternary Complete Assemblies, Stainless Steel - Cartridge and Housing

Description	ASI Part Number
Ternary Tee Mixer Assembly SS 800 μ L	433-0800
Ternary Tee Mixer Assembly SS 1.0 mL	433-1000
Ternary Tee Mixer Assembly SS 1.5 mL	433-1500

Binary/Ternary Assemblies Port Size: 10-32 CPI (Standard HPLC Fittings for 1/16" Tube)

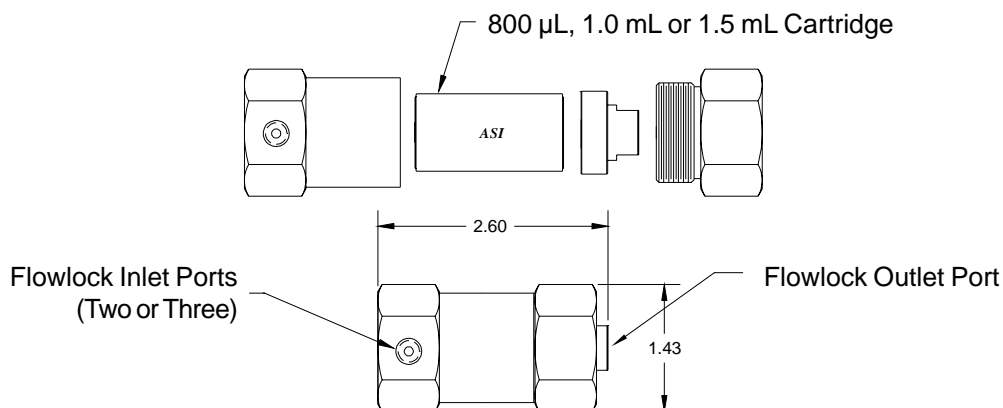

Figure 22

Cartridges / Housings Stainless Steel

Description	ASI Part Number
Mixer Cartridge SS 800 μ L	430-0800
Mixer Cartridge SS 1.0 mL	430-1000
Mixer Cartridge SS 1.5 mL	430-1500
In-Line High Flow Series SS Housing	431-0000
Binary Tee High Flow Series SS Housing	432-0000
Ternary Tee High Flow Series SS Housing	433-0000

Biocompatible PEEK

Description	ASI Part Number
Mixer Cartridge PEEK 800 μ L	430-0800B
Mixer Cartridge PEEK 1.0 mL	430-1000B
Mixer Cartridge PEEK 1.5 mL	430-1500B
In-Line High Flow Series PEEK Housing	431-0000B

UHPLC In-Line Complete Assemblies - Cartridge and Housing Stainless Steel

Description	ASI Part Number
In-Line Mixer Assembly SS 800 μ L, HP	431-0800HP
In-Line Mixer Assembly SS 1.0 mL, HP	431-1000HP
In-Line Mixer Assembly SS 1.5 mL, HP	431-1500HP

UHPLC Binary Complete Assemblies - Cartridge and Housing Stainless Steel

Description	ASI Part Number
Binary Tee Mixer Assembly SS 800 μ L, HP	432-0800HP
Binary Tee Mixer Assembly SS 1.0 mL, HP	432-1000HP
Binary Tee Mixer Assembly SS 1.5 mL, HP	432-1500HP

UHPLC Ternary Complete Assemblies - Cartridge and Housing Stainless Steel

Description	ASI Part Number
Ternary Tee Mixer Assembly SS 800 μ L, HP	433-0800HP
Ternary Tee Mixer Assembly SS 1.0 mL, HP	433-1000HP
Ternary Tee Mixer Assembly SS 1.5 mL, HP	433-1500HP

Combo Micro Series

Stainless Steel, Biocompatible PEEK



Order Instruction

You can choose any 2, 3 or 4 cartridge combination from 0.5 µL, 1 µL, 2 µL, 5 µL, 10 µL and 25 µL mixer cartridges to create the desired volume to fit your application. The minimum volume you can create will be 2 x 0.5 µL cartridge combination and the maximum volume will be 4 x 25 µL cartridge combination. You will be able to create almost the exact volume you need within that range.

Example)

For a 4 mixer assembly if you choose 1 x 5 µL, 1 x 10 µL and 2 x 25 µL combination, you will get 65 µL volume mixer.

You can specify as below when you order:

In-Line Complete Assembly SS: 491-5-10-25-25

In-Line Complete Assembly PEEK: 491-5-10-25-25B

In-Line Assemblies Port Size: 10-32 CPI (Standard HPLC Fittings for 1/16" Tube)

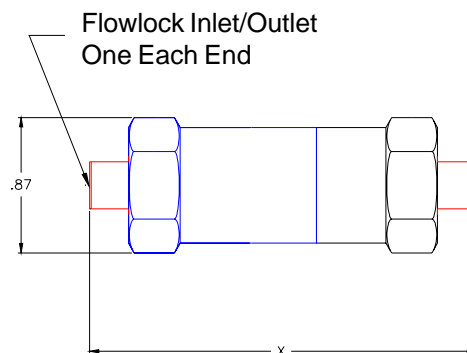

4 Mixers: X = 2.48

3 Mixers: X = 2.10

2 Mixers: X = 1.72

Figure 23

In-Line Complete Assemblies - 2, 3 or 4 Cartridge Combination and Housing Stainless Steel

Description	ASI Part Number
In-Line Combo Micro 2 Mixer Assembly SS	471-x-x
In-Line Combo Micro 3 Mixer Assembly SS	481-x-x-x
In-Line Combo Micro 4 Mixer Assembly SS	491-x-x-x-x

UHPLC Stainless Steel

Description	ASI Part Number
In-Line Combo Micro 2 Mixer Assembly SS, HP	471-x-xHP
In-Line Combo Micro 3 Mixer Assembly SS, HP	481-x-x-xHP
In-Line Combo Micro 4 Mixer Assembly SS, HP	491-x-x-x-xHP

Biocompatible PEEK

Description	ASI Part Number
In-Line Combo Micro 2 Mixer Assembly PEEK	471-x-xB
In-Line Combo Micro 3 Mixer Assembly PEEK	481-x-x-xB
In-Line Combo Micro 4 Mixer Assembly PEEK	491-x-x-x-xB

The application and Use of ASI/Combo Micro Static Mixers

Chromatographers seeking to optimize mixing volumes at flow rates below 100 $\mu\text{L}/\text{min}$. now have the ability to customize a mixing volume which is perfectly tuned to match the separation system. Choosing the right mixing volume is always a compromise between absolute noise reduction, delay volume, and gradient distortion. Ideally the optimum mixing volume should be determined experimentally by evaluating several mixing volumes to determine which provides optimum chromatographic performance. For the separation below at 50 $\mu\text{L}/\text{Min}$., a 50 μL mixer contributes too much delay volume and gradient distortion. The ASI/Combo 35 μL (25 μL + 10 μL) mixer provides just the right balance between noise reduction and gradient performance.

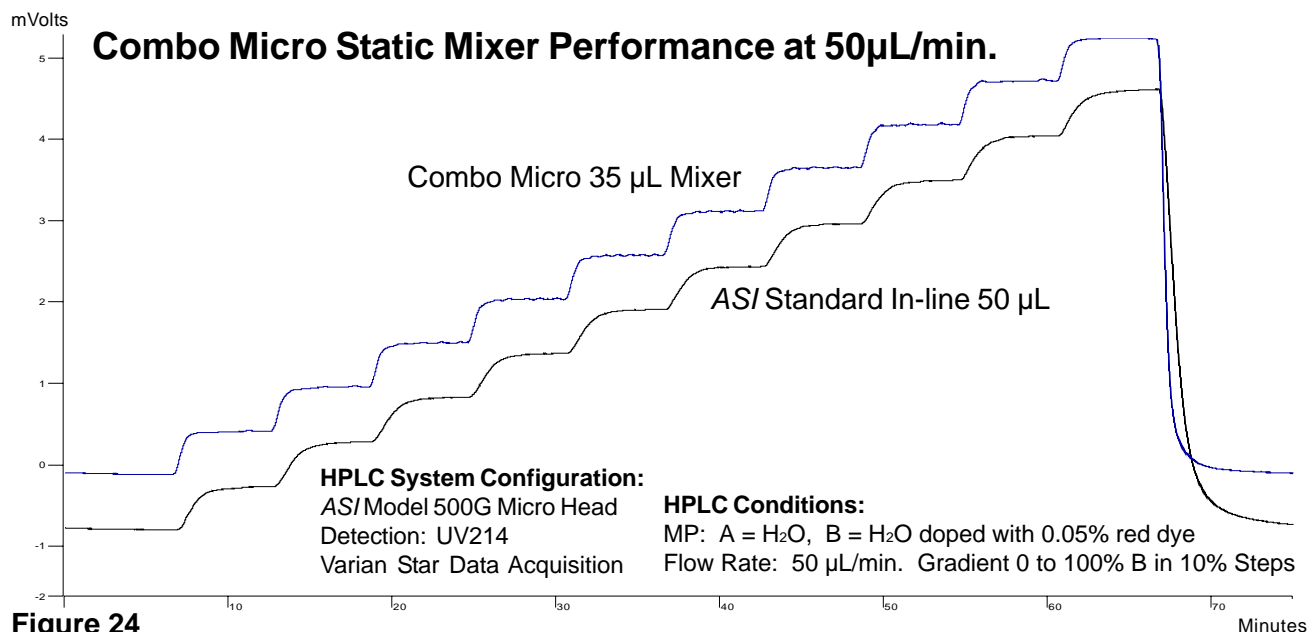

***HyperShear*TM Dynamic Mixers**



HyperShear Dynamic Mixer

***HyperShear*TM Dynamic Mixer Features:**

- Vortex shear mixing that is twice as efficient as conventional stir bar mixers
- Compact design allows easy integration into any HPLC system
- Available for Binary and Ternary formats in volumes ranging from 150 ì L to 1000 mL

The *ASI* dynamic mixer uses the same principal as our static mixers, except additional energy is added to the flow stream by a magnetically coupled rotor. This results in far greater mixing for the same amount of mixer dead volume, but also results in more flush-out volume and tailing than static mixers. Dynamic mixers work best in steady state flow conditions when multiple solvents need to be mixed. TFA presents another application where the *ASI* dynamic mixer performs well. The 492-1000A is frequently used to solve TFA mixing problems with the Agilent 1100 pump.

Please contact us for more information.



Analytical Scientific Instruments US, Inc.
3023 Research Drive Richmond CA 94806 USA
www.hplc-asi.com
Ph:800-344-4340
Customer Service: info@hplc-asi.com